



New LED Flood Light

LUXEON

BY PHILIPS LUMILEDS



Xitanium LED Driver



Mechanical drawing

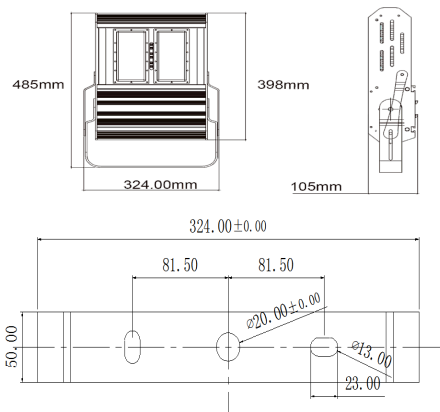

Photometrics

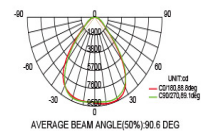
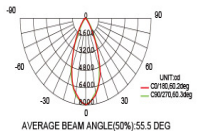
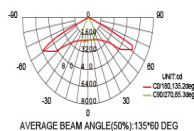
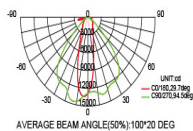
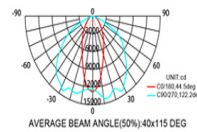
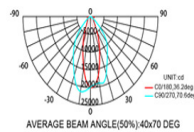
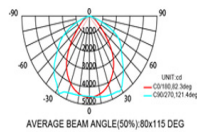

Specification

Electrical

LED Power	94.5W
System Power	105W
Input Voltage	220-240V 90-305V
Power supply/Driver	Philips Xitanium Inventronics
Power factor	≥0.98
THD	<10%

Optical

LED Source	Lumileds LUXEON M
LED Efficiency	140-150Lm/w
LED QTY	12
Luminous Flux (lm)	11832
Beam Angle	15° / 30° / 60° / 60°*135°
Color Temperature	3000K, 4000K, 5000K, 5700K
CRI	Ra70, Ra80, Ra90
Lumen Maintenance	L98B10@ 50,000 Hours
SDCM (MacAdam ellipse)	<3
Optical Lens	Polycarbonate

Control & Dimming

Dimming	1-10v DALI
Switch off	Optional
Wireless	Zigbee
Daylight sensor	Optional
Motion sensor	Optional
Wireless sensor	Optional

General

Working Temperature	-40°C ~ 55°C
Frame color	Aluminum
Frame material	Aluminum 6063
Surface Treatment	Anodizing & Electrophoresis
Bracket	Steel/stainless steel
Accessories	-
Installation way	Wall, ceiling, surface mounted
Life Span	100,000hrs
Warranty	5 years
Net Weight (kg)	8
Gross Weight (kg)	10
Packing size (cm)	55*38*20

Certificate & protection

IK Class	IK10
D-mark	Yes
IP-protection	IP65
Surge Protection	6kv/10kv
Certificate	CE SAA ENEC CB

