

LED Explosion Proof Light FHC5401



Ex marking: Ex de op is IIC T5 Gb
Ex op is tb IIIC T95°C Db, IP66



Application

- It can be widely used in petrochemical plants, oil platforms, oil pump housing, transit stations and other flammable and explosive places as fixed lighting.
- Gas explosive environment: Group IIA, IIB, IIC.
- Zone1, Zone2; Zone21, Zone22

Characteristics

- It is made using a special aluminum housing, suitable for long-term highly corrosive environment of offshore platforms, chlor-alkali, hydrogen sulfide, etc.
 - Derrick mounting fixture adopt high anti-corrosive aluminum and locking angle equipment, can be safely used in drilling platforms and high vibration environment.
 - The anti corrosion, abrasion proof, power coated cover which is dust proof, water proof, make the lamp an excellent high pressure environment
 - Bracket, reflector, guard, and all exposed fasteners adopt 304 stainless steel (customizable 316), can effectively guarantee the strength and strong anti-corrosion performance of lamp
 - Terminals are provided at both ends, can be directly wired in parallel, eliminating the junction box and installation costs.
- A variety of installation as optional: ceiling, oil derrick, the side walls, curved rods, boom, etc.

Light distribution curve

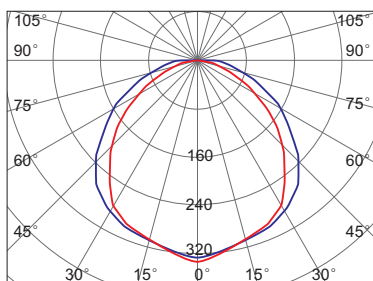

2 × 20W(T8 led tube) — 0°
— 90°
Distance high : 1.5

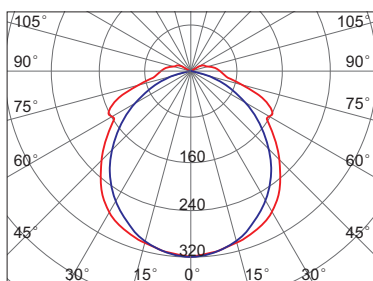

2 × 10W (T8 led tube) — 0°
— 90°
Distance high : 1.5

Main Specification

Item	Technical Parameters			
Rated wattage (W)	2 × 20W(T8)	2 × 10W (T8)	2 × 28W (T5)	2 × 14W (T5)
Input voltage (V)	90~264VAC		220~240VAC, 110VAC	
Rated frequency	50Hz / 60Hz		50Hz / 60Hz	
Light source	LED		Fluorescent	
Light output (lm)	3600	1800	3400	1700
CRI (Ra)	80		70	
Life time (h)	50,000		8,000	
CCT	5000K		6500K	
Cable entry thread	M20×1.5, M25×1.5, NPT3/4", NPT1/2", G3/4"			
Terminals	Multi core: ≤2.5mm ²			
	Single core: ≤4mm ²			
Dimension (mm)	1390 × 180 × 110	780 × 180 × 110	1390 × 180 × 110	780 × 180 × 110
Net weight (kg)	10.7	6.6	10.7	6.6



Drawing of dimension (Dimensions in mm)

Ceiling mounting

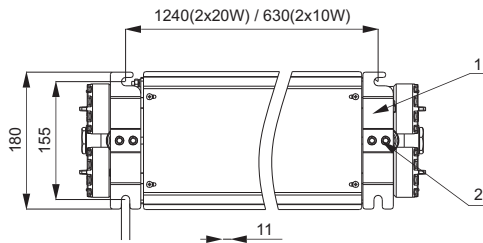
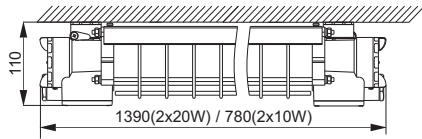

Lamps Ordering Information

Order No.	Mounting type	Lamp power	Equivalent to
			Fluorescent
FHC5401-L20A	Ceiling	2×10W	2×20W
FHC5401-L40A		2×20W	2×40W

Fitting Ordering Information (Standard)

Order No.	No.	Specifications Model	Quantity
P01	1	Ceiling Bracket	2
	2	M8 Inner six angle bolt	4

Derrick mounting

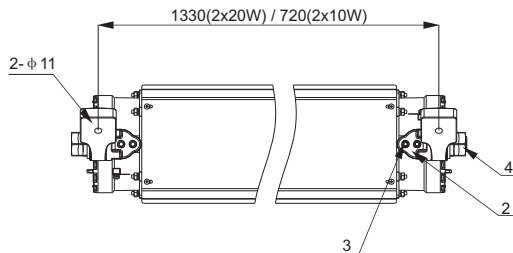
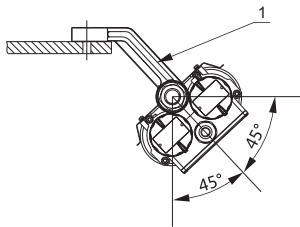

Lamps Ordering Information

Order No.	Mounting type	Lamp power	Equivalent to
			Fluorescent
FHC5401-L20A	Derrick type	2×10W	2×20W
FHC5401-L40A		2×20W	2×40W

Fitting Ordering Information(Optional)

Order No.	No.	Specifications Model	Quantity
P02	1	Derrick bracket	2
	2	Base	2
	3	M8 Inner six angle bolt	4
	4	M24 screw	2

LED Explosion Proof Light FHC5401



Side wall mounting

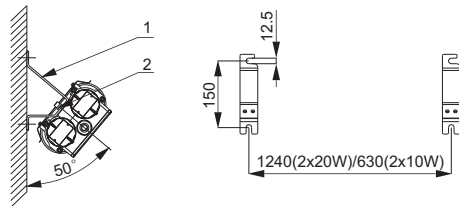

Lamps Ordering Information

Order No.	Mounting type	Lamp power	Equivalent to
			Fluorescent
FHC5401-L20A	Side wall	2×10W	2×20W
FHC5401-L40A		2×20W	2×40W

Fitting Ordering Information (Optional)

Order No.	No.	Specifications Model	Quantity
P03	1	Sidewall bracke	2
	2	M10 Inner six angle bolt	4

Pole mounting

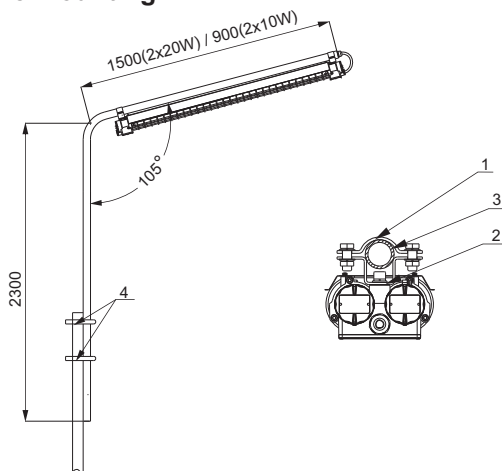

Lamps Ordering Information

Order No.	Mounting type	Lamp power	Equivalent to
			Fluorescent
FHC5401-L20A	Pole	2×10W	2×20W
FHC5401-L40A		2×20W	2×40W

Fitting Ordering Information (Optional)

Order No.	No.	Specifications Model	Quantity
P04	1	Upper hoop	2
	2	Under hoop	2
	3	DN32 Poles	1
	4	U tube clip	2

Ceiling mounting 2

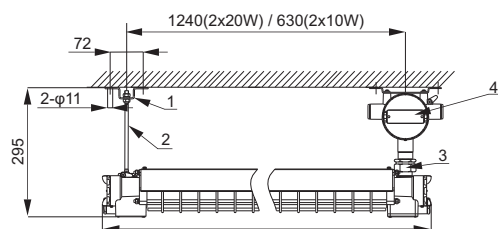

Lamps Ordering Information

Order No.	Mounting type	Lamp power	Equivalent to
			Fluorescent
FHC5401-L20B	Ceiling	2×10W	2×20W
FHC5401-L40B		2×20W	2×40W

Fitting Ordering Information (Optional)

Order No.	No.	Specifications Model	Quantity
P05	1	Pole mounting bracket	1
	2	19cm Screw(M8)	1
P02	3	Connector G3/4" male- male	1
BHD01	4	Explosion proof junction box	1

