

FH Solar & Led Ibérica

We are good energy

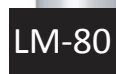

ISO9001
ISO14001



LED STREET LIGHTS

www.fhsolarled.com



LED power supply



+ NON-DIMMABLE

High-end MeanWell HLG Series LED driver, optimal stability, performance and lifespan.



LED DRIVER inside

+ DIMMABLE

High-end programmable Inventronics LED driver, integrate dimming function and 6KV /10KV surge protection. Provide excellent performance and lifespan.



Easy Maintenance

Tool-less quick-release latches for speedy access.



Photocell available

Lamp will Auto turn on and off according to lux difference.



Surge protection device(10KV)

To provide more reliable guarantee for LED driver, extend the life of the product.



Power turn off protector (Only Post Top Mounted available)

Under maintenance, when the fixtures be opened, the power will be cut off to protect personal safety.

High-efficacy LED light source



Philips Lumileds 3030 2D
Greater than 165lm/W high efficacy, illumination grade LED light source.



Imported breather

Lamp breather ensures air balance inside and outside of the lamp, which improves lamp's service life.

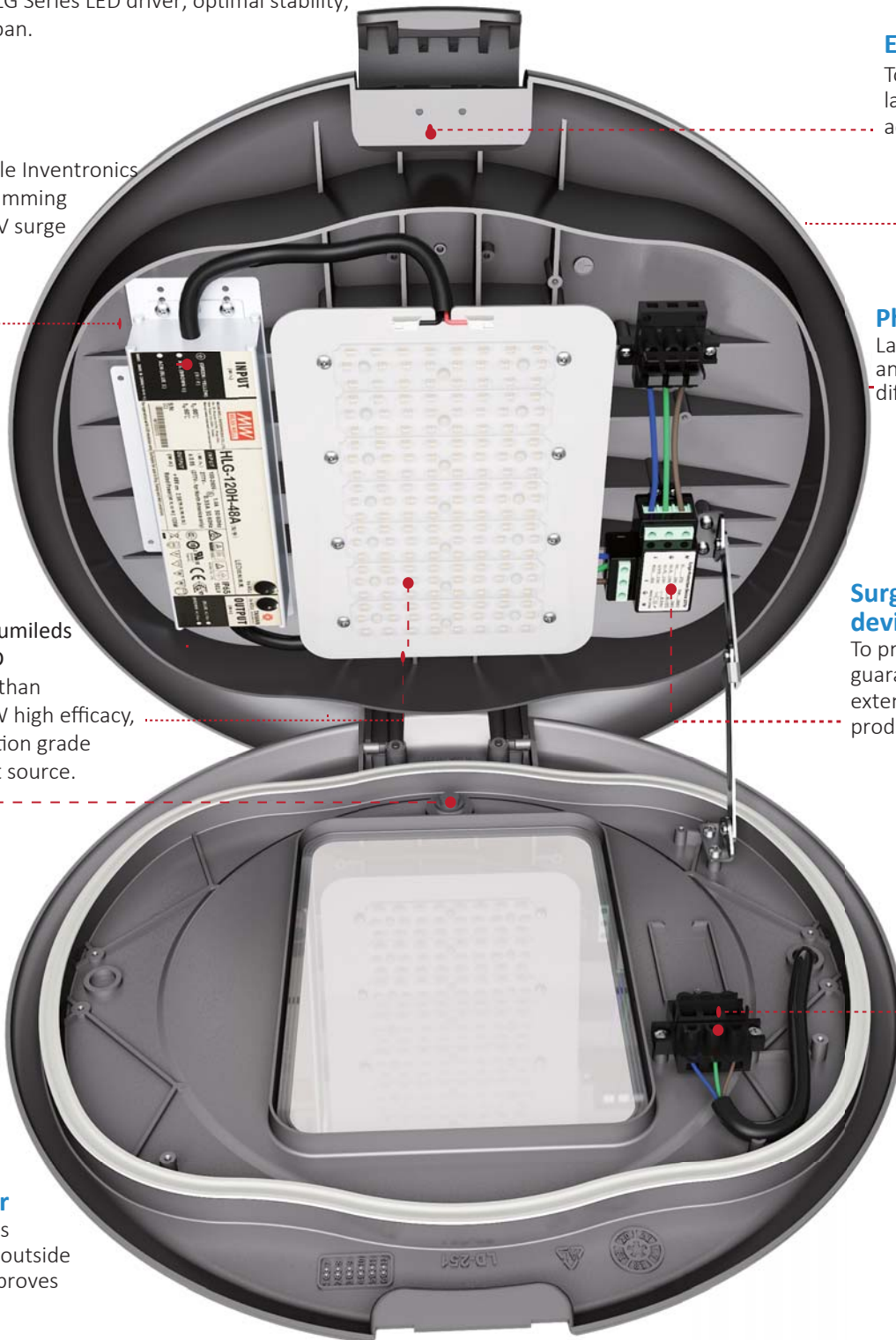

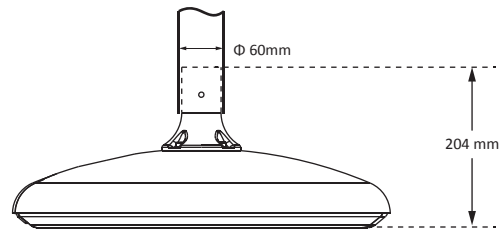
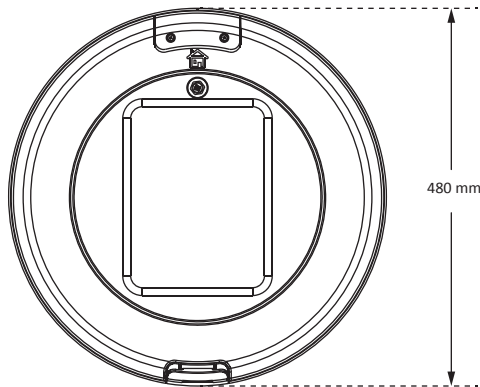

Pendant Mounted

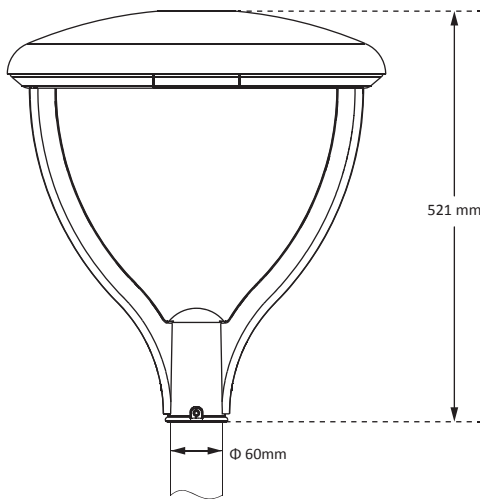

Post Top Mounted

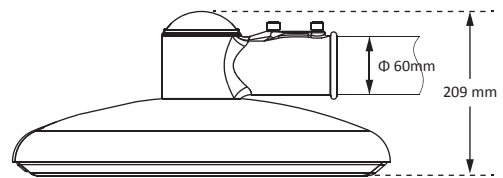

Side Entry Mounted

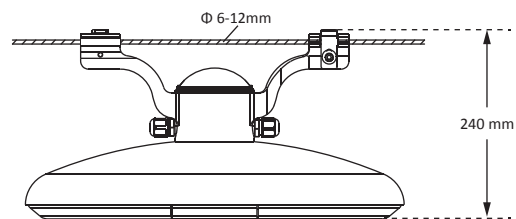

Suspended Mounted

Packing Details

★ Luminaire [Side Entry Mounted and Suspended Mounted]

Model	Carton Size (mm)	N.W (kg)	G.W (kg)
FH-3L27LM	495*495*170	7.4	9.1
FH-3L37LM	495*495*170	7.6	9.3
FH-3L56LM	495*495*170	7.7	9.4
FH-3L70LM	495*495*170	7.8	9.5
FH-3L90LM	495*495*170	7.9	9.6
FH-3L120LM	495*495*170	7.9	9.6

Note: Above data of weight are all typical values.

★ Accessories [Side Entry Mounted and Suspended Mounted]

Mounted Type	Carton Size (mm)	N.W (kg)	G.W (kg)
Side Entry Mounted	235*125*105	1.0	1.5
Suspended Mounted	355*150*105	0.8	1.5

Note: Above data of weight are all typical values.

★ Luminaire and Accessories [Post Top Mounted and Pendant Mounted]

Model	Carton Size (mm)	Post Top Mounted		Pendant Mounted	
		N.W(kg)	G.W(kg)	N.W(kg)	G.W(kg)
FH-3-L27LM	495*495*170	8.7	10.4	7.6	9.3
FH-3LD37LM	495*495*170	8.9	10.6	7.8	9.5
FH-3L56LM	495*495*170	9.0	10.7	7.9	9.6
FH-3L70LM	495*495*170	9.1	10.8	8.0	9.7
FH-3L90LM	495*495*170	9.2	10.9	8.1	9.8
FH-3L120LM	495*495*170	9.2	10.9	8.1	9.8

Note: Above data of weight are all typical values.

SERIES-FH-3

LED STREET LIGHTS

PRODUCT CATALOG

Electrical & Photometric

A: Post Top Mounted

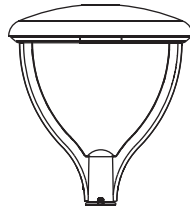

B: Pendant Mounted

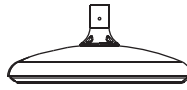

C: Side Entry Mounted

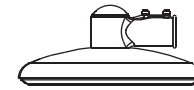

D: Suspended Mounted

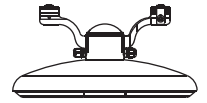

Order Reference
FH-3-L120LM A

Series	Model	LED Qty/ Current	Power	Luminaire efficacy (+/- 5%)	Lumen Output (+/- 5%)	Input Voltage	LED Brand	Driver Brand	Light Distributions	CCT (K)	Surge Protection Device	Lifetime (h)
L	FH-3L27LM	72units/ 56mA	27W	130 lm /w*1	3510 lm	100-240V /277V AC 50 /60Hz	Philips Lumileds 3030 2D	MeanWell Inventronics	1M, 2M, 3M, 5S*2	3000*3 4000 5000 5700	10KV	>100,000 (L70)
	FH-3L37LM	96units/ 59mA	37W	130 lm /w*1	4810 lm							
	FH-3L56LM	120units/ 70mA	56W	130 lm /w*1	7280 lm							
	FH-3L70LM	144units/ 78mA	70W	130 lm /w*1	9100 lm							
	FH-3L90LM	168units/ 86mA	90W	130 lm /w*1	11700 lm							
	FH-3L120LM	168units/ 110mA	120W	125 lm /w*1	15000 lm							

*1 Luminous Efficacy of post top mounted is 10% lower than other installation methods.

*2 Luminous Efficacy of 5S is 10% higher than other Light Distributions.

*3 Luminous Efficacy of 3000K is 5% lower than other CCTs.

Mechanical

Model	Working Environment	Storage Temperature	Rating	CRI	Power Factor	Power Efficiency	Material	Pole/ Rope Diameter (mm)
FH-3L27LM	-40 °C ~ +50 °C 10% ~ 90%RH	-40 °C ~ +50 °C	Class I IP66 IK08	>70	>0.95	>90%	Housing: Die-cast aluminum Lens: Tempered glass and PC	Side Entry Mounted: Φ 60mm(External diameter of the pole)
FH-3L37LM								Suspended Mounted: Φ 6-12mm(External diameter of the rope)
FH-3L56LM								Post Top Mounted: Φ 60mm(External diameter of the pole)
FH-3L70LM								Pendant Mounted: Φ 60mm(Internal diameter of the pole)
FH-3L90LM								
FH-3L120LM								

Note: Above data of weight are all typical values.

Dimming Optional

Inventronics driver will be used if dimming function is requested.
Multiple dimming functions are integrated (0-5V DC or 0-10V DC or PWM Signal or Timer).

- ★ 0-5V Dimming [All the models over 56W are available]
- ★ 0(1)-10V Dimming [All the models are available except 27W]
- ★ PWM Dimming [All the models over 56W are available]
- ★ Timer Dimming [All the models over 56W are available]

Certification

Manufacturer
ISO9001, ISO14001
FH3 Series [FH-3L27LM, FH-3L37LM, FH-3L56LM, FH-3L70LM, FH-3L90LM, FH-3L120LM]
CE, ROHS, LM80

Light Distributions

★ Pendant Mounted | Side Entry Mounted | Suspended Mounted

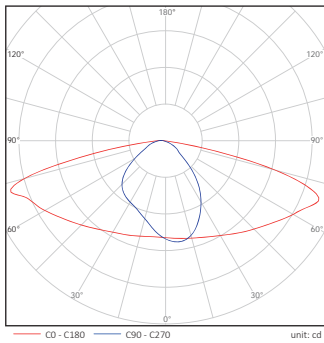

Type I

Application
Single Driveway
Walkway
Cycleway
Branch Road

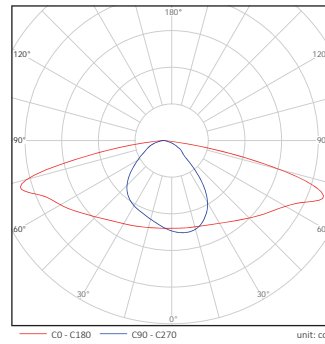

Type II

Application
Two Driveway
Driveway Entrance
Urban main roads

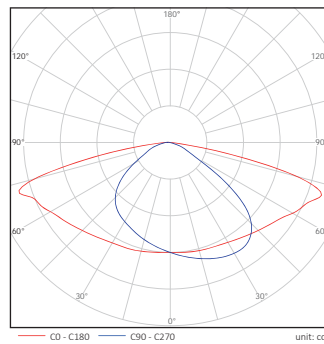

Type III

Application
Three Driveway
Urban main roads
Parking Lot/Area

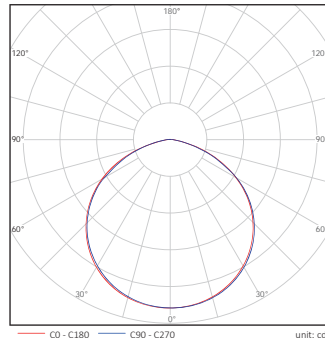

Type V

Application
Parking lot
Square
Garden
Area

★ Post Top Mounted

Type I

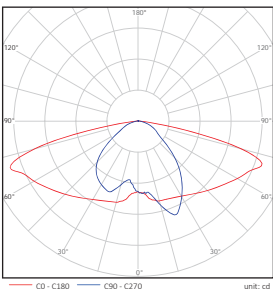

Type II

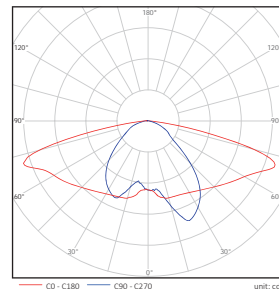

Type III

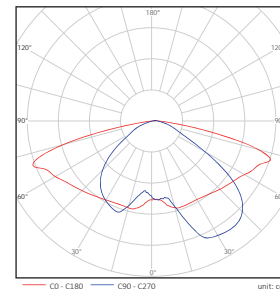

Type V

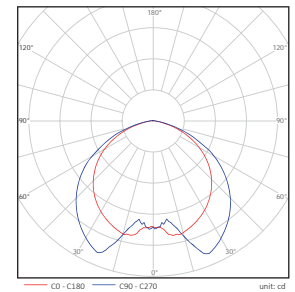

Application: Public garden | Public park | Parking Lot | Path way

Optical Control

Optical control function is supported by optional

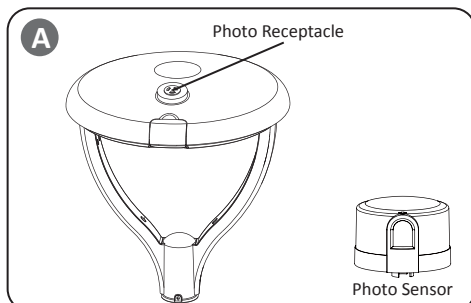

If the fixture has PHOTO CONTROL function, the Photo Receptacle will be installed on the cover of fixture. See **A**. Fit the pins of Photo Sensor to Photo Receptacle, firmly insert and rotate Photo Sensor to proper position.

<Verifying>

Make sure all the connections done and photo control is well installed on the fixture, switch on the power supply and cover the window of photo sensor, wait 5 seconds, the fixture will be turned on.



FH Solar & Led Ibérica

Núñez Morgado 5 Madrid 28036

Phone : +34 913235993

Mobile : +34 600027027

Fax : +34 913231054

E-mail : info@fhsolarled.com

Spain



México > Colombia > Spain