

LED STREET LIGHTS

Urban roads Acla



SAVE ENERGY FOR TOMORROW



5 YEAR
WARRANTY

Areas of application

- Lighting of roads -
- Docks -
- Bridges -
- Parks -
- Residential area -



ISO 9001
ISO14001
ISO45001
ISO50001



Product Benefits

- 70% energy saving, short ROI period
- Up to 100,000hrs @ L70, low maintenance cost
- World class, approved quality components (LEDs /Driver /etc.
- Support horizontal and vertical mounted, suitable for different light pole
- Tool-less opening of driver box, ease of maintenance
- Spring latch pin design allows for tool-free removal of the main luminaire body, easy to replace
- 5 years warranty

Product Features

- Luminaire efficacy: Up to 176 lm /
- Lifetime more than 100,000 hour
- Impact resistance: IK0
- Type of protection: IP6



LED STREET LIGHTS





Product Datasheet

Structure Drawing:

Control System Support
(Photocell, NEMA /ZHAGA socket)

10kV Surge protection device

Knife switch

Spring latch pin design allows
for tool-free removal of the
main luminaire body

High end Programmable LED Driver

Toolless open clip

Tempered glass Cover with
UV-resistant Polycarbonate

Vent

Adjustable Fitter
(+ / - 0-5-10-15 degrees)

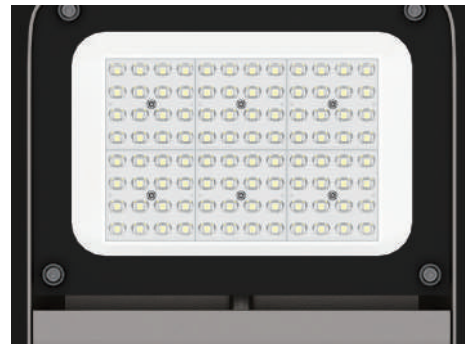

Product Datasheet

Version S

Model No		FH-ST23-30S	FH-ST23-40S	FH-ST23-50S	FH-ST23-60S
Nominal Wattage		30W	40W	50W	60W
3030 Version	Efficiency Lumen	150 lm /w 4500 lm	150 lm /w 6000 lm	150 lm /w 7500 lm	140 lm /w 8400 lm
5050 Version	Efficiency Lumen	160 lm /w 4800 lm	160 lm /w 6400 lm	160 lm /w 8000 lm	160 lm /w 9600 lm
Ultra Version (Only valid for CCT 4000K)	Efficiency Lumen	176 lm /w 5280 lm	176 lm /w 7040 lm	176 lm /w 8800 lm	176 lm /w 10560 lm
Net Weight (Kgs)		3.3	3.3	3.3	3.3
Packing Size (mm)		470 x240 x180	470 x240 x180	470 x240 x180	470 x240 x180
Gross Weight (Kgs)		3.8	3.8	3.8	3.8

Version M

Model No		FH-ST23-80M	FH-ST23-100M
Nominal Wattage		80W	100W
3030 Version	Efficiency Lumen	140 lm /w 11200 lm	140 lm /w 14000 lm
5050 Version	Efficiency Lumen	160 lm /w 12800 lm	160 lm /w 16000 lm
Ultra Version (Only valid for CCT 4000K)	Efficiency Lumen	176 lm /w 14080 lm	176 lm /w 17600 lm
Net Weight (Kgs)		4.0	4.0
Packing Size (mm)		470 x287 x180	470 x287 x180
Gross Weight (Kgs)		4.6	4.6

Version L

Model No		FH-ST23-120L	FH-ST23-150L
Nominal Wattage		120W	150W
3030 Version	Efficiency Lumen	140 lm /w 16800 lm	145 lm /w 21750 lm
5050 Version	Efficiency Lumen	160 lm /w 19200 lm	160 lm /w 24000 lm
Ultra Version (Only valid for CCT 4000K)	Efficiency Lumen	176 lm /w 21120 lm	176 lm /w 26400 lm
Net Weight (Kgs)		5.4	5.4
Packing Size (mm)		550 x357 x180	550 x357 x180
Gross Weight (Kgs)		6.3	6.3

Version XL

Model No		FH-ST23-180XL	FH-ST23-200XL	FH-ST23-240XL
Nominal Wattage		180W	200W	240W
3030 Version	Efficiency Lumen	150 lm /w 27000 lm	150 lm /w 30000 lm	150 lm /w 36000 lm
5050 Version	Efficiency Lumen	160 lm /w 28800 lm	160 lm /w 32000 lm	160 lm /w 38400 lm
Ultra Version (Only valid for CCT 4000K)	Efficiency Lumen	176 lm /w 31680 lm	176 lm /w 35200 lm	176 lm /w 42240 lm
Net Weight (Kgs)		6.7	6.7	6.7
Packing Size (mm)		651 x357 x180	651 x357 x180	651 x357 x180
Gross Weight (Kgs)		7.7	7.7	7.7

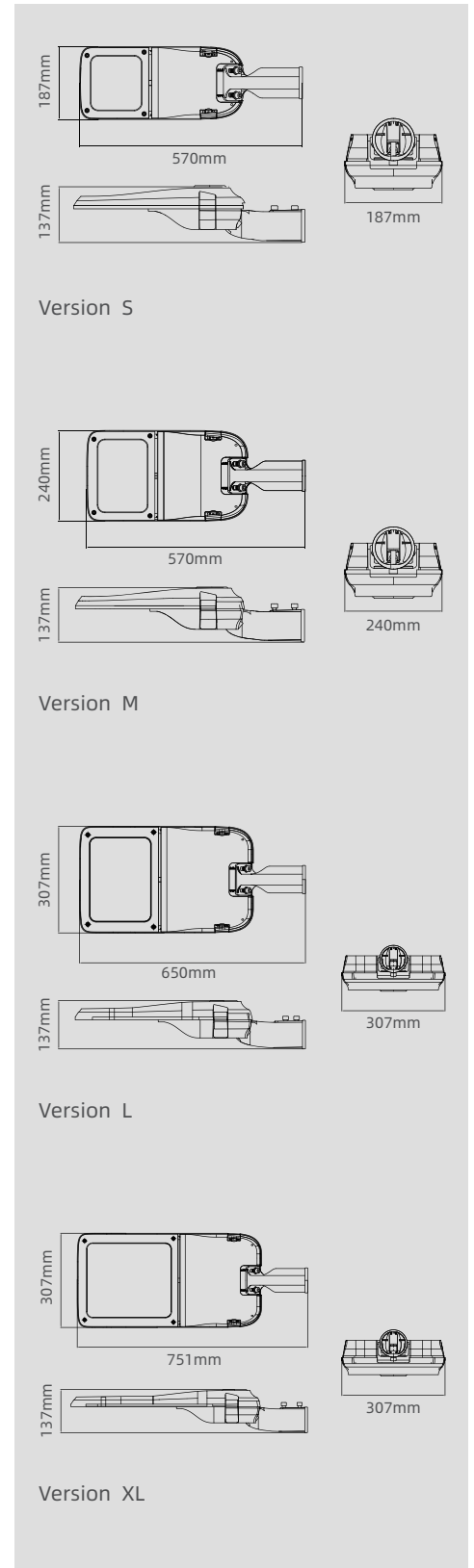

-The net weight of the product does not include the weight of the light control base or other controllers.

-Above values are calculated based on the product with CCT over 3000K, values of 3000K are 5% lower than above values.

-Values shown are subject to ±5% tolerance.

Product Datasheet

Electrical Data:

Nominal Voltage	AC 100-240V / 277V 50 / 60Hz
LED	Lumileds /Other brands on request
Driver	Inventronics /Other brands on request
Power Factor (PF)	>0.95
THD	<15
SPD	10KV (Default) /20KV (available on request)
Optics	Type II, Type III, Asymmetric for pedestrian crossings
Standard Deviation of Color Matching	<5 SDCM
CRI	Ra>70 (Default) /Ra>80
CCT	1800K, 2200K, 2700K, 3000K, 4000K, 5000K, 5700K, 6500K

General Data

Body Material	High pressure die-cast aluminum
Housing Color	Gray-RAL9007 (Default) /Other Colors on request
Cover Material	Tempered glass
Lens Material	UV-resistant Polycarbonate
Working Environment	-40°C ~ +50°C, 10%~90%RH
Lifespan L70 at 25 °C	>100, 000 h
Mounting Type	Side entry or Vertical pole mounted
Dimmable	1-10V Dimming (Default) /Timer Dimming /DALI Dimming
Protection Class	Class I (Default) /Class II
Certifications & Standards	CE, RoHS, ENEC , CB, LM79, LM80, TM-21, IEC62471, IEC60068-2-6, IEC61643-11
Available on request	NEMA socket (3/5/7pins), ZHAGA socket, Short cap, Photocell, Motion sensor, NTC, OLC, Solar Compatible, Smart Controller

Packaging

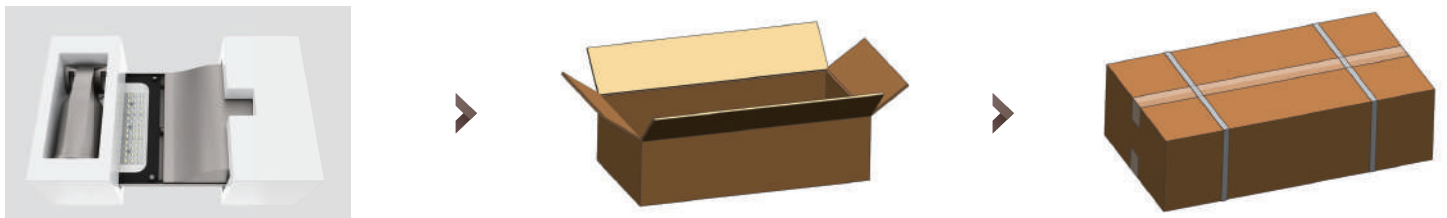

Flexible Fitter

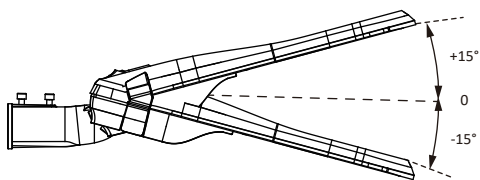

Horizontal Installation
±0-5-10-15°

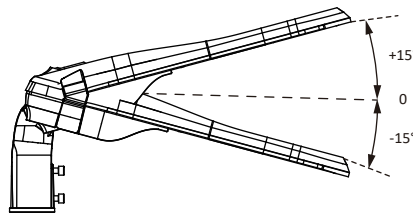

Vertical Installation
±0-5-10-15°

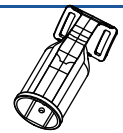

Fitter Diameter:
32-42mm/1.26-1.65"

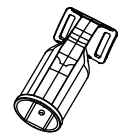

Fitter Diameter:
48-60mm/1.89-2.36"

Product Datasheet

Order reference

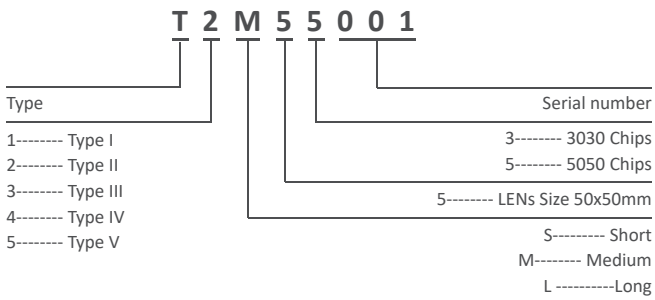

Light Distributions

3030 Version

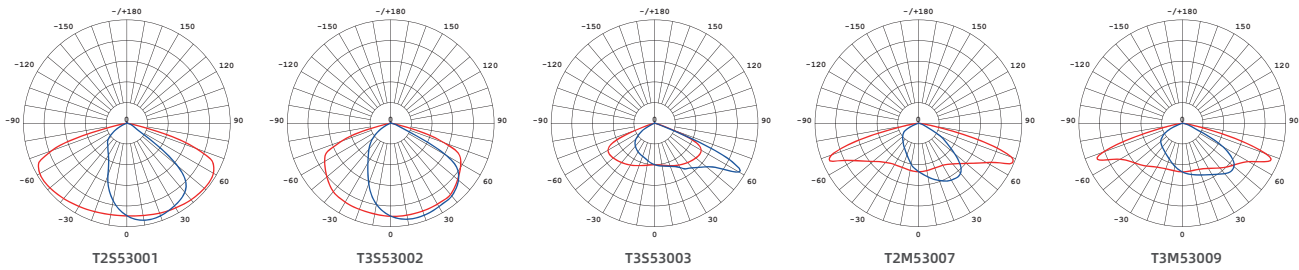

5050 Version

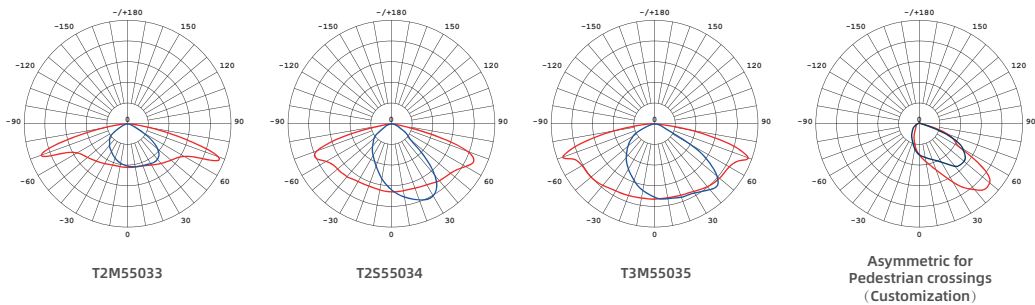

Optional Accessories

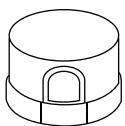

Photocell



Shorting Cap

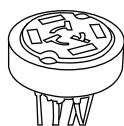

NEMA Socket
(3 / 5 / 7pin)

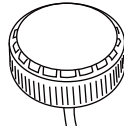

Motion Sensor



Smart Controller

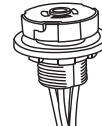

ZHAGA Socket

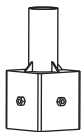

Square to round

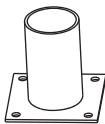

"T" Type

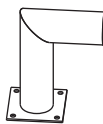

"L" Type

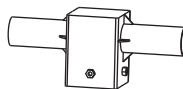

"2" in "1"

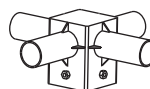

"4" in "1"

LED STREET LIGHTS

Urban roads Acla

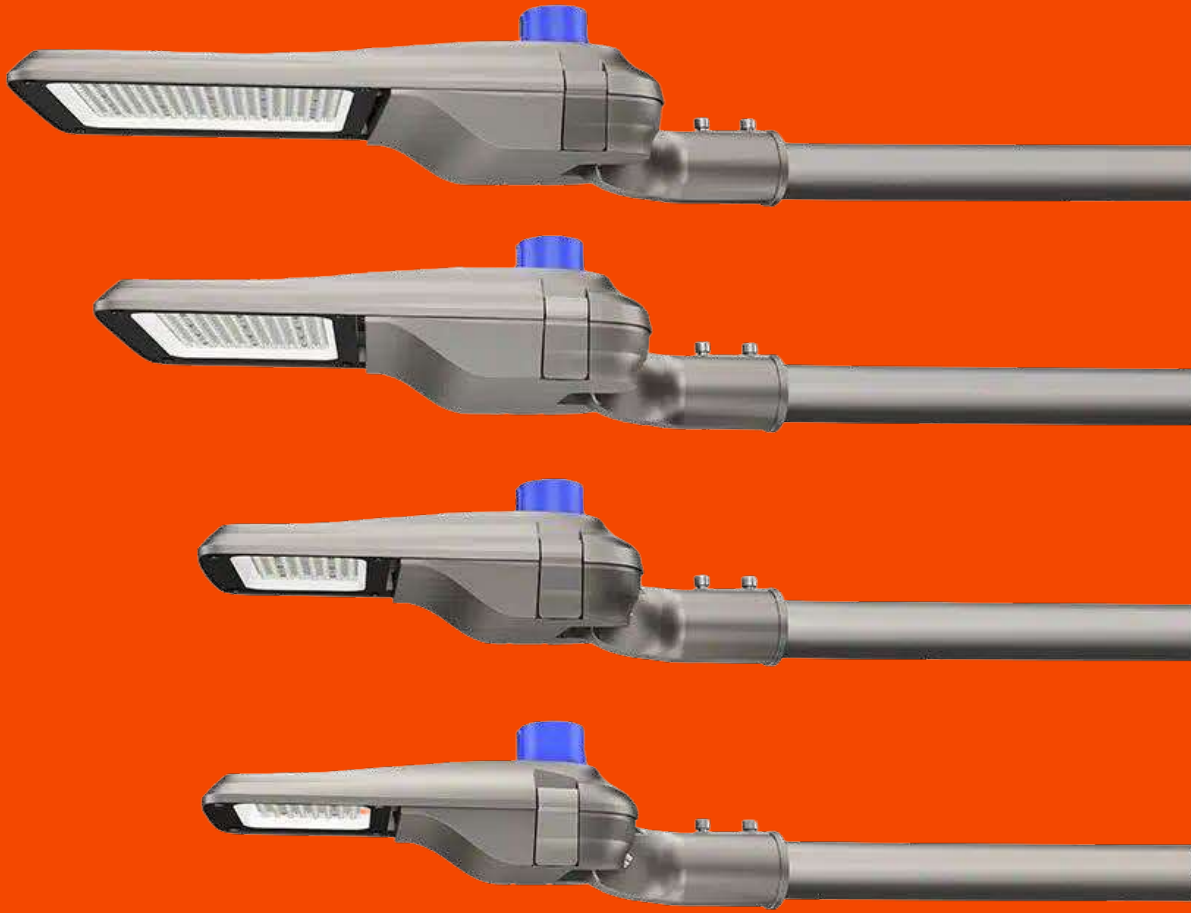

 **FHsolar&led Ibérica[®]**

Soluciones Energéticas Renovables

Calle Serrano 110 Planta 1ª Madrid 28006

Tel : +34 913235993 / 600027027

Spain . Colombia . México . Latam

www.fhsolarled.com . info@fhsolarled.com

SAVE ENERGY FOR TOMORROW

LED STREET LIGHTS

