

LED STREET LIGHTS

Classic 1905 Post Top LED Light

SAVE ENERGY FOR TOMORROW



5 YEAR WARRANTY

Product Overview



Smart Control System Optional

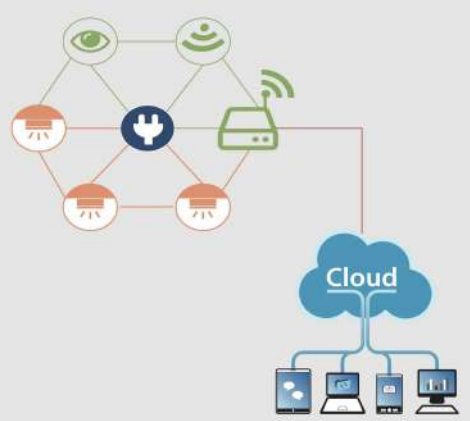

NEMA Zhaga

LoRa ↓ ZigBee



IP66

LED STREET LIGHTS



HEAT DISSIPATION PERFORMANCE

Advanced FEA technology designs for the structure thermal transfer to guarantee the LED PCB and chips can use for long lite

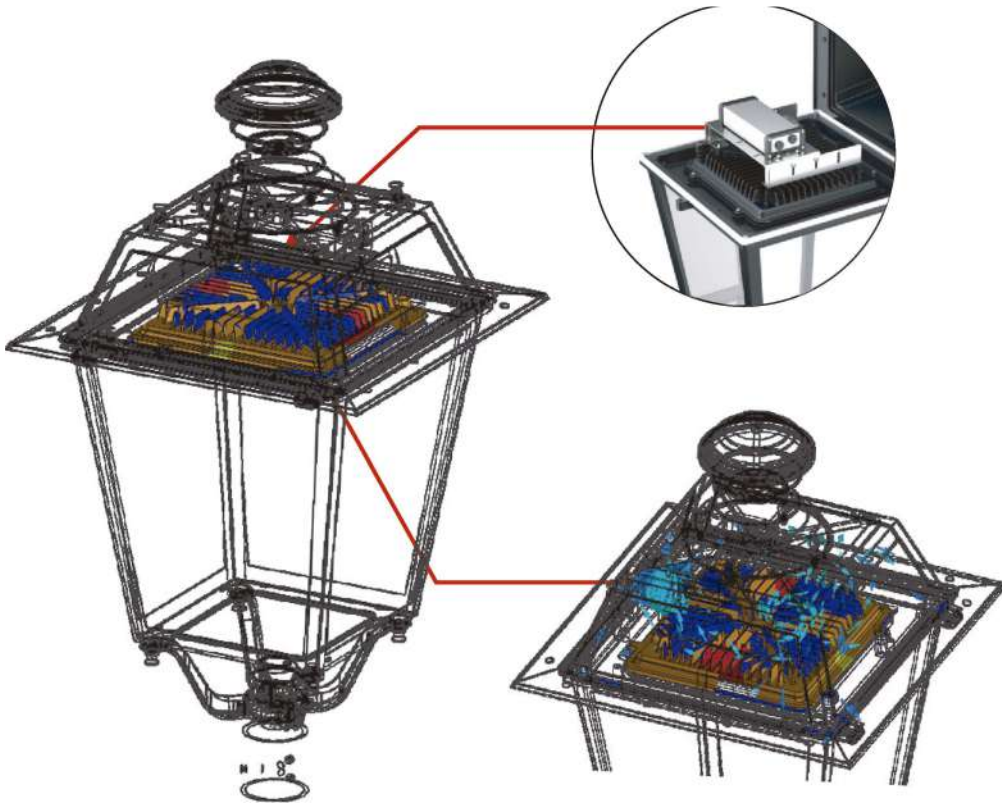

Non-contact structure for LED drivers and heat sinks. The electrical parts are in cool status.

Die-casting aluminum heat sinker is designed inside. The air convection structure enhances the lumen maintenance performance.

Unit: mm

FHG-1094A

FHG-10948

346

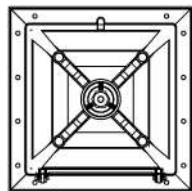
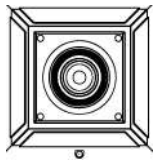

446

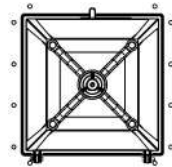
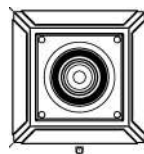

∅ 76

686



∅ 76



Light Distributions

3030 Version

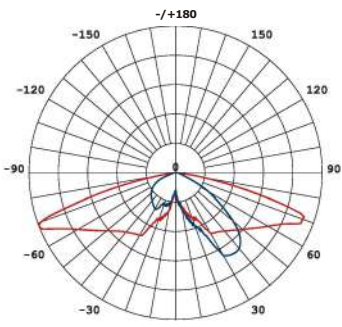

T2M53007

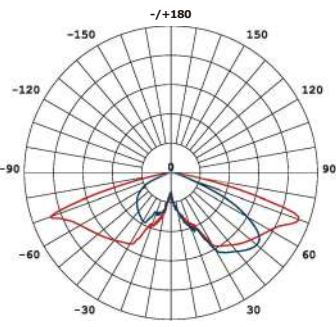

T3M53009

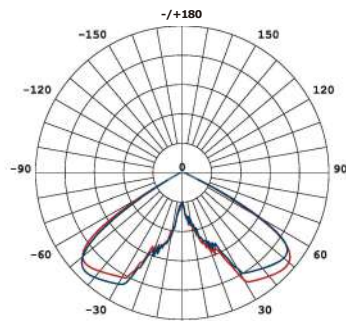

120D53014

5050 Version

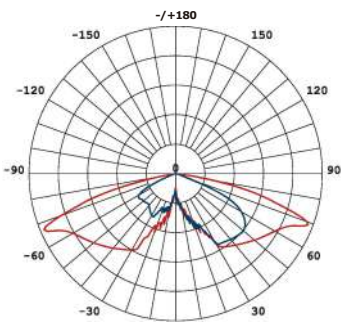

T2M55008

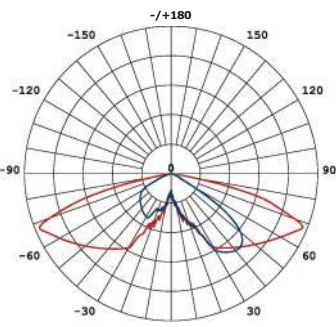

T3M55010

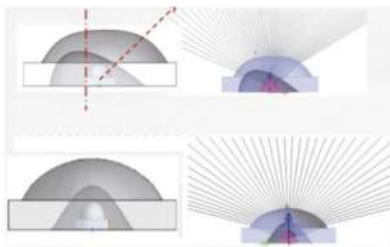

Asymmetric
Optics

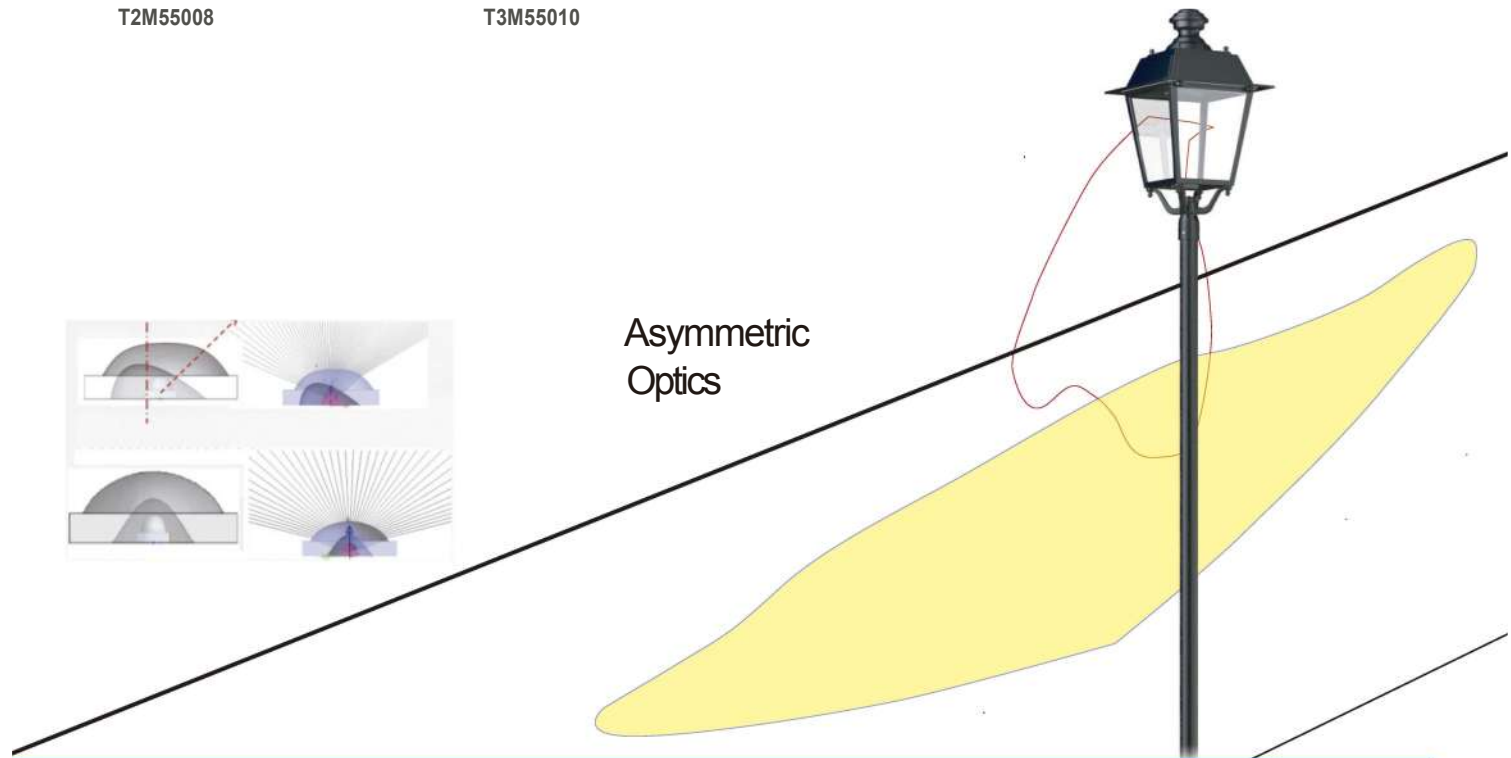

Product Datasheet

SUGGESTED
INSTALLATION HEIGHT

CHARACTERS

Model No	FHG-1094A-40	FHG-1094A-60	FHG-10948-80	FHG-10948-100
Power	40W	60W	80W	100W
Protection Class	CLASS 1/11			
IP/IK Rating	IP66, IK08			
Color Temperature	2200K-6500K	2200K-6500K	2200K-6500K	2200K-6500K
Efficiency(3030 Version)	110 LM/W	110 LM/W	125 LM/W	120 LM/W
Efficiency(5050 Version) CRI	120 LM/W	120 LM/W	130 LM/W	130 LM/W
Input Voltage	70/80	70/80	70/80	70/80
Driver Suggest	100-240/277Vac,50/60Hz			
Dimming	INVENTRONICS			
Surge Recommendation	1-1 0V Dimming (Default) /Timer Dimming 1			
LED Type	0KV (Default) / 20KV (available on request)			
LED Quantities 3030	LUMILEDS			
Pcb Input Current (3030)	64	96	144	144
LED Quantities 5050	48V 740mA	48V 1125mA	48V 1516mA	48V 1920mA
Pcb Input Current (5050)	24	36	54	54
Mounting	48V 800mA	48V 1212mA	48V 1650mA	48V 2090mA
Material	On pole with 76 mm top diameter, adaptor 60 mm top diameter can be chosen			
Painting Color Suggest	Die casting with standard adcl 2 type aluminum, tempered glass, stainless 314 clips and screws. Clear polycarbonate with uv-resistant acrylic. Option for screen for asymmetrical light.			
Available on request	RAL9005 Jet 8black /Other Colors on request			
Weight	NEMA socket (3/5/7pins), ZHAGA socket, Short cap, Photocell, NTC, OLC, DALI Dimming			
Packing Size	Net weight: 6.8kgs Gross weight: 8.8kgs		Net weight: 8.8kgs Gross weight: 10.5kgs	
	380 x380 x550mm		480 x480 x700mm	

Classic 1905 Post Top LED Lights



 **FHsolar&led Ibérica[®]**

Soluciones Energéticas Renovables

Calle Serrano 110 Planta 1ª Madrid 28006

Tel : +34 913235993 / 600027027

Spain . Colombia . México . Latam

www.fhsolarled.com . info@fhsolarled.com

SAVE ENERGY FOR TOMORROW

LED STREET LIGHTS

