

LED SPOT LIGHT

ITEM NO.: FH310B Series

INSTRUCTION OF LED SPOT LIGHT/FH310B

This production is mainly used for decorating and highlighting in building frame, garden, etc. It can work in independent mode and DMX mode, which can generate various color changing effects, such as flashing, fading, steady, seven color jumping synchronously etc. DMX256 class gray degree dimmable, DMX programmable (thousands of effects available if many lights being connected together);

***When the mode is on steady color, please skip B&C parts .

A. Specification

A-1. Structure

Materials of Shell: Aluminum alloy
 Rotary angle: 120°
 Input Voltage: 120V AC 240V AC 277V AC
 Operating Voltage: 48V DC
 Protecting Rating: IP65
 Operating Temperature: -20°C~40°C



SP-F310B-52P-DMX

A-2. Model Configuration Table

Model No.	Size	LED Color	LED Quantity	Power consumption	Beam Angel	Weight
FH310B-26P-DMX	L270XW320XH303mm	RGBW(4in1)	26pcs Power LED/4W	75WATTS	15/30/40/15*35°	6kg±5%
FH310B-52P-DMX	L400XW320XH303mm	RGBW(4in1)	52pcs Power LED/4W	150WATTS	15/30/40/15*35°	11kg±5%

B. Working Mode:

- B-1. Independent Mode: Choose the build-in programs via the buttons on the end cover.
- B-2. DMX Mode: International standard DMX 512.
- B-3. Master/Slave Mode: Auto online and synchro working.
- B-4. The white LEDs cannot mix together with RGB at the same time.

C. Function & Setup

C-1. Independent mode

After pressing **A** four times (the first three times is the setup on DMX address) or **B** directly, light enter into independent mode; the digital LEDs show **PXY**, press **A** once, active digital LEDs move backward, you can choose function via **X** and parameter via **Y**; Press **B**, the corresponding flash digital LED increases one bit (range: 1~9).

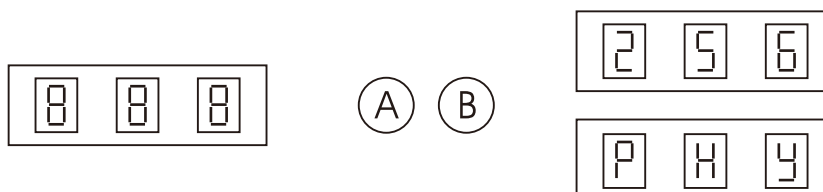

X refers to functions (the value between 1 to b), **Y** refers to value of speed and gray degree for the functions (the value between 1 to 9). When pressing button, please wait for about 10 sec, then you can exit the mode of adjustment function, the digital LED stop flashing and data recorded.

LED SPOT LIGHT

ITEM NO.: FH310B Series

Function and parameter sheet:

X value	Y value
1-static red	1~9 class gray degree
2-static green	1~9 class gray degree
3-static yellow	1~9 class gray degree
4-static blue	1~9 class gray degree
5-static purple	1~9 class gray degree
6-static cyan	1~9 class gray degree

X value	Y value
7-staic white	1~9 class gray degree
8-multicolor changing	1~9 class speed
9-single fading	1~9 class speed
A-multicolor fading	1~9 class speed
B-multicolor flashing	1~9 class speed
C-autorun	1~9 times circle

C-2. DMX Mode

1. DMX Addressing

When the digital LED is not flashing,press **A**,digital LED begin to flash,press **A** once, active digital LEDs moves backward,you can start to edit the second digital LED;Press **B**, the corresponding flash digital LED increase one bit (the values between 1 to 9).

2. DMX Channel instruction-4 Channels available as sheet:

CHANNEL 1		CHANNEL 2		CHANNEL 3		CHANNEL 4	
Data	Function	Data	Function	Data	Function	Data	Function
0~255	Brightness of Red	0~255	Brightness of Green	0~255	Brightness of Blue	0~255	Brightness of White

***Enter or quit DMX mode automatically once detecting valid signal!!!

C-3. Master/Slave Mode

Choose any one light as the master for attaining auto online function,the operations are as below: firstly,set the address of master as 001,others are set as slave (address can be any one except 001); Change function of the master (001) light,then all lights will work synchronously;

D. Photometrics Parameters

D-1. Cadela Distribution

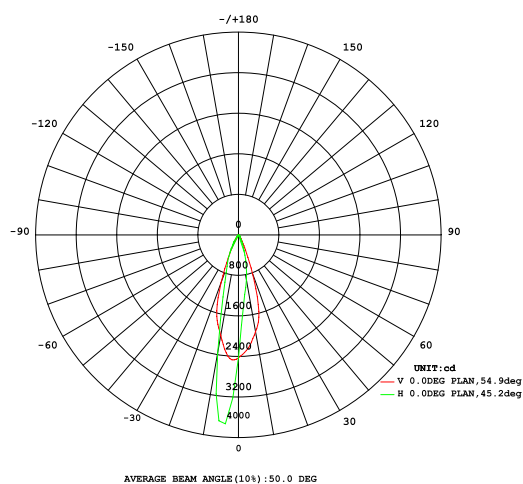

FH310B-52P-DMX

D-2. Illuminance At A Distance

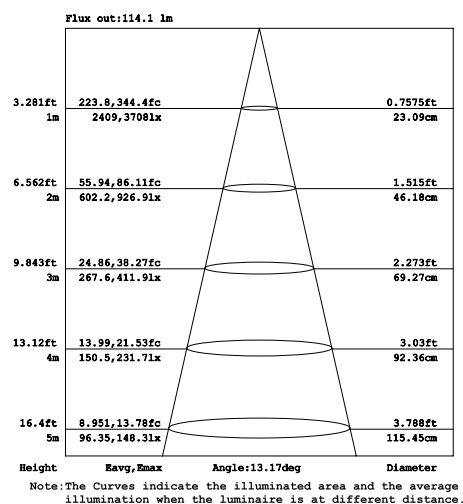

LED SPOT LIGHT

ITEM NO.: FH310B Series

E. Dimension Drawing

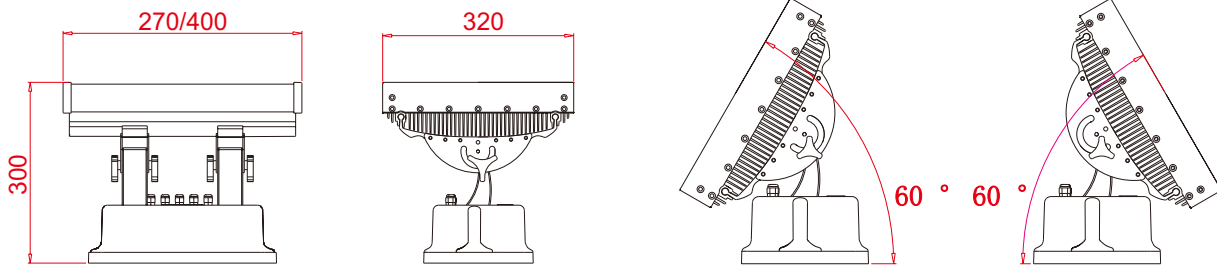

F. Installation Drawing

Fix the brackets via M10 bolt, the light is suitable for ground mounting. Size as below:

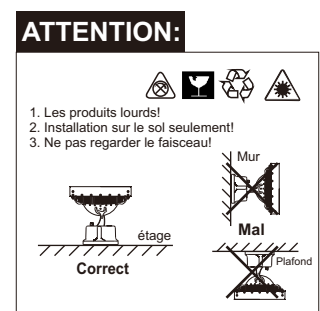
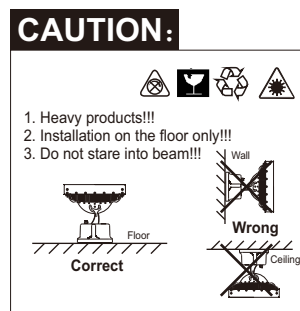
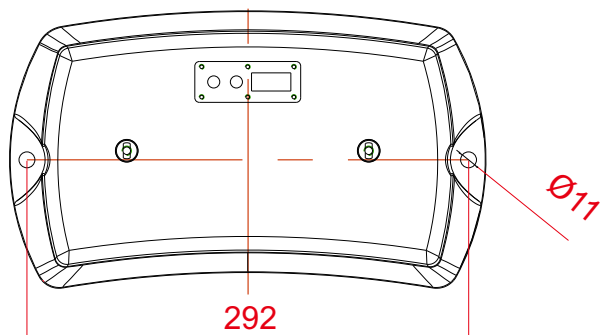

G. Connection

G-1. Signal max connection is 100m, more than 100m or 60pcs fixtures need a signal amplifier.

G-2. Optional controller: MASTER PRO, Sunlite, DMX-192C, Madrix and other DMX controller.

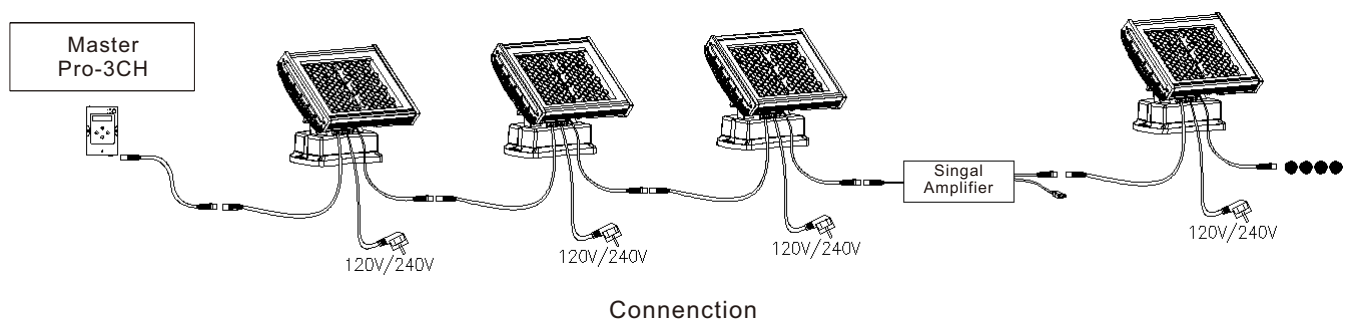

LED SPOT LIGHT

ITEM NO.: FH310B Series

H. Waterproof Treatment

The signal output connector XLR-3 of the last fixture of each series must be sealed with a 20mm thermal shrinking tube(-1), blow and shrink it with a hair driers; then wrapped with waterproof tape (auto-adhesive, please refer to below instruction for operation) on both side; Blow the second 25mm shrink tube(-2) at last so as to protect waterproof tape under sunshine and guarantee the waterproof validity.

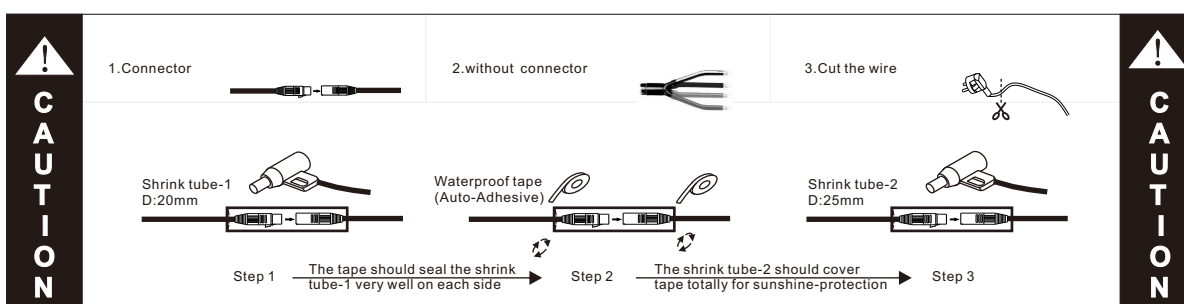

***Neglect on action of the above treatment will lead to failure of waterproof and proper work of the lights!!!

***Water can be sucked into the fixture via interior pipe of the cables after light be switched off, due to minus pressure!!!

*** Power connector should be treated in the same way if available!!!

*** IP68 connector does not require above treatment, but you connect a threaded twist quite well to prevent operational errors lead to joint water

Caution:

1. Do not plug them into power when the product is still in package;
2. Don't use anything to cover the fixture during application;
3. Don't use this product in close environment;
4. If this product appears to be damaged, do not attempt any repair, please contact your dealer.

Warning:

- * Neglect on action of the above treatment will lead to failure of waterproof and proper working of the lights!!!
- * Make sure the ground connection well avoid electric shock, due to metal housing.
- * Don't cut out the updated IP68 connectors, or any failure caused must be born by buyers.

Note: The above instruction are subject to update or improved without notice. Pls turn to our staff for further details !
Thanks for your long term support !



Do not install the lamp in the lightning activity area.
N'installez pas la lampe dans la zone d'activité de l'éclairage.

The white light cannot mix together with RGB at the same time.