

LED WALL WASHER

ITEM NO: FH620A Series

INSTRUCTION OF LED WALL WASHER/FH620A

This product is mainly used for decorating and highlighting in building frame, garden, etc. It can work in independent mode and DMX mode, which can generate various color changing effects, such as flashing, fading, steady ,seven color jumping synchronously etc. DMX256 class gray degree dimmer, DMX programable (thousands of effects. available if many lights being connected together);

A. Specification:

A-1. Structure:

Materials of Shell: Aluminum alloy +Stainless steel

Rotary angle: 140°/160°

Input Voltage: 100V-240V AC

Operating Voltage: 48V DC

Protecting Rating: IP65

Operating Temperature: -20°C~40°C



SP-F620A-108P



SP-F620A-216P

A-2. Model Configuration Table

Model No.	LED Color	LED Quantity	Power Consumption	Beam Angle	Size	Weight	✓
FH620A-108P	R,G,B/WW/NW/W	108	216 WATTS	15°/30°/45°	L320xW620xH350mm	25.5kg±5%	
FH620A-216P	R,G,B/WW/NW/W	216	430 WATTS	15°/30°/45°	L670xW620xH440mm	42.5kg±5%	

B. Working Mode:

B-1. Independent Mode: Built-in auto run programs.

B-2. DMX Mode: International standard DMX512 signal.

B-3. Master/Slave Mode: Auto online and synchro working.

B-1. Mode indépendant: Intégré dans le programme auto-exécutable

B-2. Mode DMX: Signal de norme internationale DMX512.

B-3. Mode maître /esclave: Auto en ligne et travail synchro.

C. Function & Setup

C-1. DMX Addressing:

This product has 3 DMX channels, **use "Master-Pro" for addressing**, for details please refer to its instruction.

***Valid DMX address : 001~512

Ce produit dispose de 3 canaux DMX, **utilisez "Master-Pro" pour l'adressage**, pour plus de détails s'il vous plaît se référer à son instruction.

***Adresse Valid DMX: 001~512

LED WALL WASHER

ITEM NO: FH620A Series

DMX Channel instruction-3 Channels available as sheet:

CHANNEL 1		CHANNEL 2		CHANNEL 3	
Data	Function	Data	Function	Data	Function
0~255	Brightness of Red	0~255	Brightness of Green	0~255	Brightness of Blue

***Enter or quit DMX mode automatically once detecting valid signal!!!

CANAL 1		CANAL 2		CANAL 3	
Données	Fonction	Données	Fonction	Données	Fonction
0~255	Luminosité de Red	0~255	Luminosité de Green	0~255	Luminosité de Blue

*** Entrée ou quitter le mode DMX automatiquement une fois la détection de signal valide!

C-2. Independent Mode:

Light will be entered into independent mode automatically without DMX signal. It will be circled as multicolor changing, single color fading, multicolor fading, multicolor flashing orderly.

Lumière sera enterd en mode indépendant automatiquement sans DMX signal. It sera entouré comme changement multicolore, unique décoloration, multicolore décoloration, multicolore clignotant ordonnée.

C-3. Master/Slave Mode:

Choose any one light as the master for attaining auto online function, the operations are as below: firstly, set the address of master as 001, others set as slave (address can be any one except 001); Change function of master (001) light, then all lights will work synchronously.

Choisissez une quelconque lumière en tant que maître pour atteindre la fonction automatique de ligne, les opérations sont les suivantes: tout d'abord, définir l'adresse de maître que 001, d'autres fixent comme esclave (adresse peut être l'un quelconque sauf 001); la fonction de changement de maître (001) lumière, puis toutes les lumières ne fonctionnent synchronously.

D. Photometric Parameters:

D-1. Cadela Distribution

FH620A-216P Beam Angle: 10°

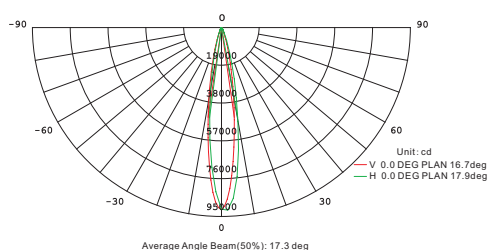

RGB

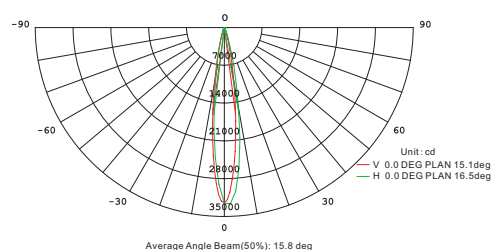

Red

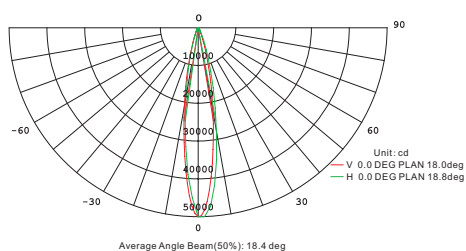

Green

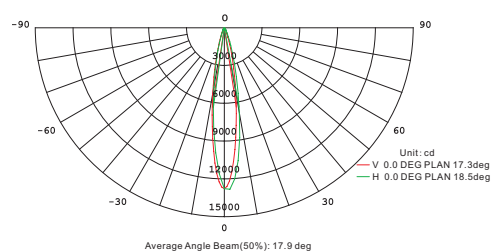

Blue

D-2. Illuminance At A Distance

LED WALL WASHER

ITEM NO: FH620A Series

F620A-216P Beam Angle:10°

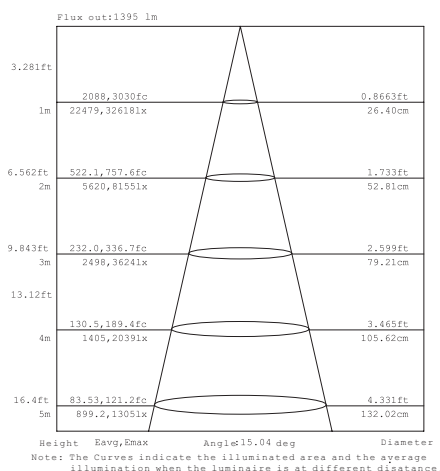
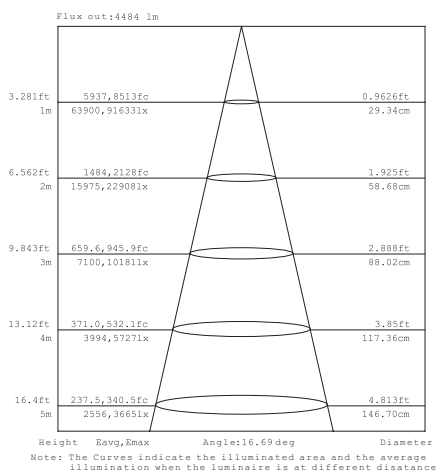

RGB

Red

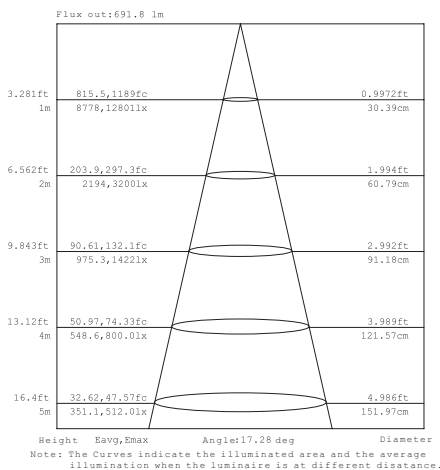
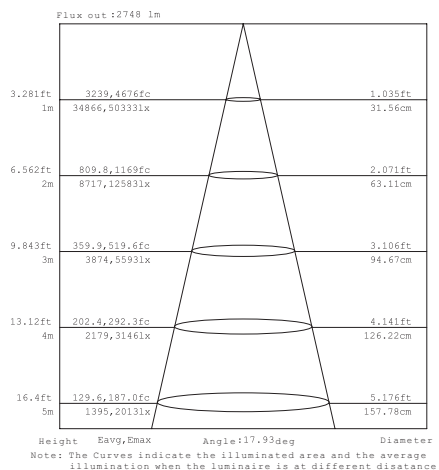

Green

Blue

E. Dimension Drawing:

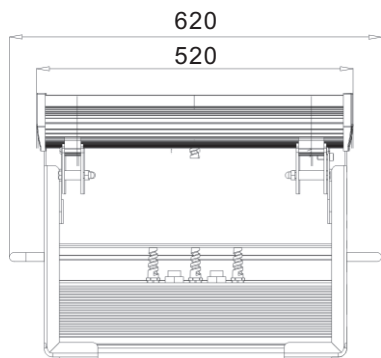

FH620A-108/216P

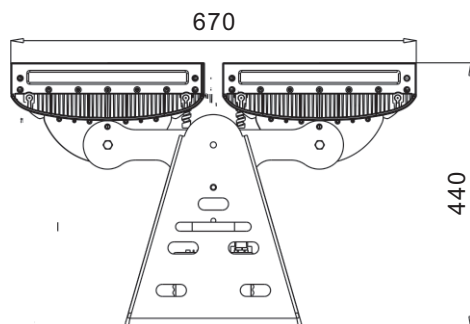

FH620A-216P

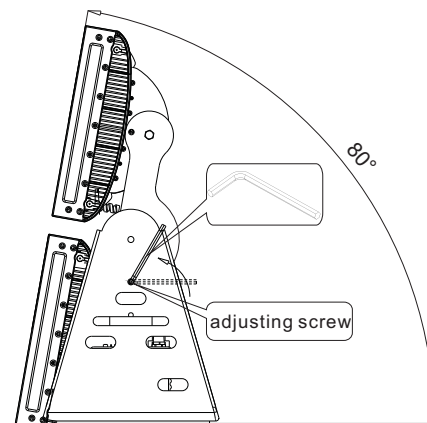

(Unscrew the adjusting screws by socket head wrench, then rotating it)

LED WALL WASHER

ITEM NO: FH620A Series

H. Waterproof Treatment

The signal output connector XLR-3 of the last fixture of each series must be sealed with a 20mm thermal shrinking tube(-1), blow and shrink it with a hair driers; thence wrapped with waterproof tape (auto-adhesive, please refer to below instruction for operation) on both side; Blow the second 25mm shrink tube(-2) at last so as to protect waterproof tape under sunshine and guarantee the waterproof validity.

Le connecteur de sortie du signal XLR-3 du dernier appareil de chaque série doit être scellé avec un 20mm Stube rétrécissement thermique (-1), souffler et rétrécir avec cheveux séchoirs, de là enveloppé avec du ruban adhésif étanche (auto-adhésif, s'il vous plaît se référer au-dessous de l'instruction pour le fonctionnement) sur les deux côtés; Soufflez le deuxième tube de 25mm de retrait (-2) à durer de manière à protéger la bande imperméable à l'eau sous le soleil et garantir la validité étanche.

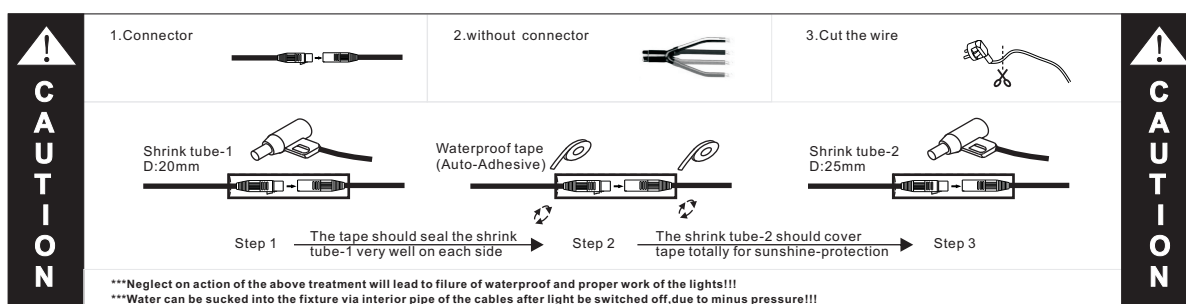

*** Power connector should be treated in the same way if available!!!

*** IP68 connector does not require above treatment, but you connect a threaded twist quite well to prevent operational errors lead to joint water

Caution:

1. Do not plug them into power when the product is still in package;
2. Don't use anything to cover the fixture during application;
3. Don't use this product in close environment;
4. If this product appears to be damaged, do not attempt any repair, please contact your dealer.

Warning:

- * Neglect on action of the above treatment will lead to failure of waterproof and proper working of the lights!!!
- * Make sure the ground connection well avoid electric shock, due to metal housing.
- * Don't cut out the updated IP68 connectors, or any failure caused must be born by buyers.

Caution:

1. Ne pas les brancher au pouvoir lorsque le produit est toujours en emballage;
2. Ne pas utiliser quoi que ce soit pour couvrir l'appareil lors de l'application;
3. Ne pas utiliser ce produit en étroite environnement;
4. Si ce produit semble endommagé, n'essayez pas toute réparation, s'il vous plaît contactez votre revendeur.

Warning:

- * Négligence sur l'action du traitement ci-dessus conduira à l'échec de imperméable et bon travail des lumières!.
- * Assurez-vous que la connexion à la terre et éviter
- * Joint de toutes les mises à jour en ip68 joint, ne

Note: The above instruction are subject to update or improved without notice. Pls turn to our staff for further details !
Thanks for your long term support !



Product .By. FH Solar & Led Ibérica [®]

www.fhsolarled.com | info@fhsolarled.com
 México .Colombia. España .Latam